



The ultimate outdoor grilling experience.

Phone: 1 (888) 287-3333 ♦ Fax: 1 (877) 855-5373 ♦ #106-2480 Mt. Lehman Road, Abbotsford, BC V4X 2N3

OWNER'S MANUAL: Searing Side Burner



**Models: JGSBSEAR-LP (Propane)
JGSBSEAR-NG (Natural Gas)**



Important Notice

Please read ALL safety notices on PP. 2 before assembling or operating this Side Burner.

Version: JAN2022

!SAFETY WARNINGS!

IMPORTANT: Please read and understand all warnings and precautions before using your Side Burner.



!DANGER!

If you smell gas:

1. Shut off gas to the appliance.
2. Extinguish any open flame.
3. Open lid.
4. If the odor continues, keep away from appliance and immediately call your gas supplier or your fire department.



!WARNING!

1. Do not store or use gasoline or other Flammable liquids or vapors in the vicinity of this or any other appliance.
2. An LP cylinder not connected for use shall not be stored in the vicinity of this or any other appliance.

- 1 This accessory is for outside use only, and shall not be used in any building, garage, enclosed area or vehicle.
 - 2 All gas connections and gas fitting should be performed by a certified gas fitter.
 - 3 This Side Burner is assembled from the factory as EITHER a Propane OR a Natural Gas appliance. Please ensure that the Side Burner is connected to the correct gas type for its gas configuration.
 - 4 Do not use gasoline, alcohol or other volatiles for lighting purposes.
 - 5 The Propane (LP) gas supply cylinder must be constructed and marked in accordance with the specifications for propane gas cylinders of the US Department of transport (DOT) CFR 49 or the National Standards of Canada, CAN/CSA B339, Cylinders, Spheres and Tubes for the Transportation of Dangerous Goods.
 - 6 Do not alter this side burner in any manner.
 - 7 Do not touch any metal surfaces on this side burner until it has completely cooled to avoid burns, unless wearing protective gear. (Pot holders, gloves, BBQ mittens, etc.)
 - 8 It is essential to keep the valve compartment, burner, and circulating air passages clean and free of obstructions and debris. Inspect the side burner before each use, and clean it regularly.
 - 9 Do not store any spare propane cylinders within 10 feet of this Side Burner.
 - 10 Please note that propane (LP) is explosive under pressure, heavier than air and settles and pools in low areas, which can create an explosion hazard.
 - 11 Caution: contact with propane gas can cause freeze burns to your skin.
 - 12 Dented and rusted propane cylinders may be Hazardous, and should be checked by a propane supplier, before use.
 - 13 This outdoor cooking gas appliance is not intended to be installed in or on boats or recreational vehicles.
 - 14 Lid must be open and in the locked position when in use. For instructions, see page 6.
-  **WARNING:** This product can expose you to chemicals including Chromium (hexavalent compounds), which are known to the State of California to cause cancer and birth defects or other reproductive harm. (For more information go to: www.P65Warnings.ca.gov)

!WARNING!

Failure to follow all the manufacturer's instructions could result in serious bodily injury, death and/or property damage.

CERTIFICATION & TESTING

This side burner has been tested by Labtest Certification (LC) and has been tested to ANSI Z21.58b-2012 & CSA 1.6b-2012, and Certified for Canada and the USA.

NOTE: The use and installation of this product must conform to local codes. In the absence of local codes, use the National Fuel and Gas Code, ANSI A223.1, Storage and Handling of Liquefied Petroleum Gasses, NFPA / ANSI 58.

TABLE OF CONTENTS

Safety Warnings:	1
Certification & Testing:	2
Package Contents Checklist:	2
Exploded Diagram & Parts List:	3
Installation Instructions: (Cart Version)	3-4
Installation Instructions: (Built In Version)	5
Lid Lock Instructions	6
Clearance to Combustibles:	7
Leak Testing:	7
Lighting Instructions:	7
Gas Conversion:	8-9
Warranty:	10

PACKAGE CONTENTS CHECKLIST:

The following parts are included in this side burner package:

- 1 x Side Burner Body with Lid (attached)
- 1 x Stainless Steel Flex Hose
- 1 x Stainless Steel Cook Grid
- 1 x Searing Burner
- 1 x Natural Gas Regulator
- 1 x Owner's Manual



EXPLODED DIAGRAM & PARTS LIST:

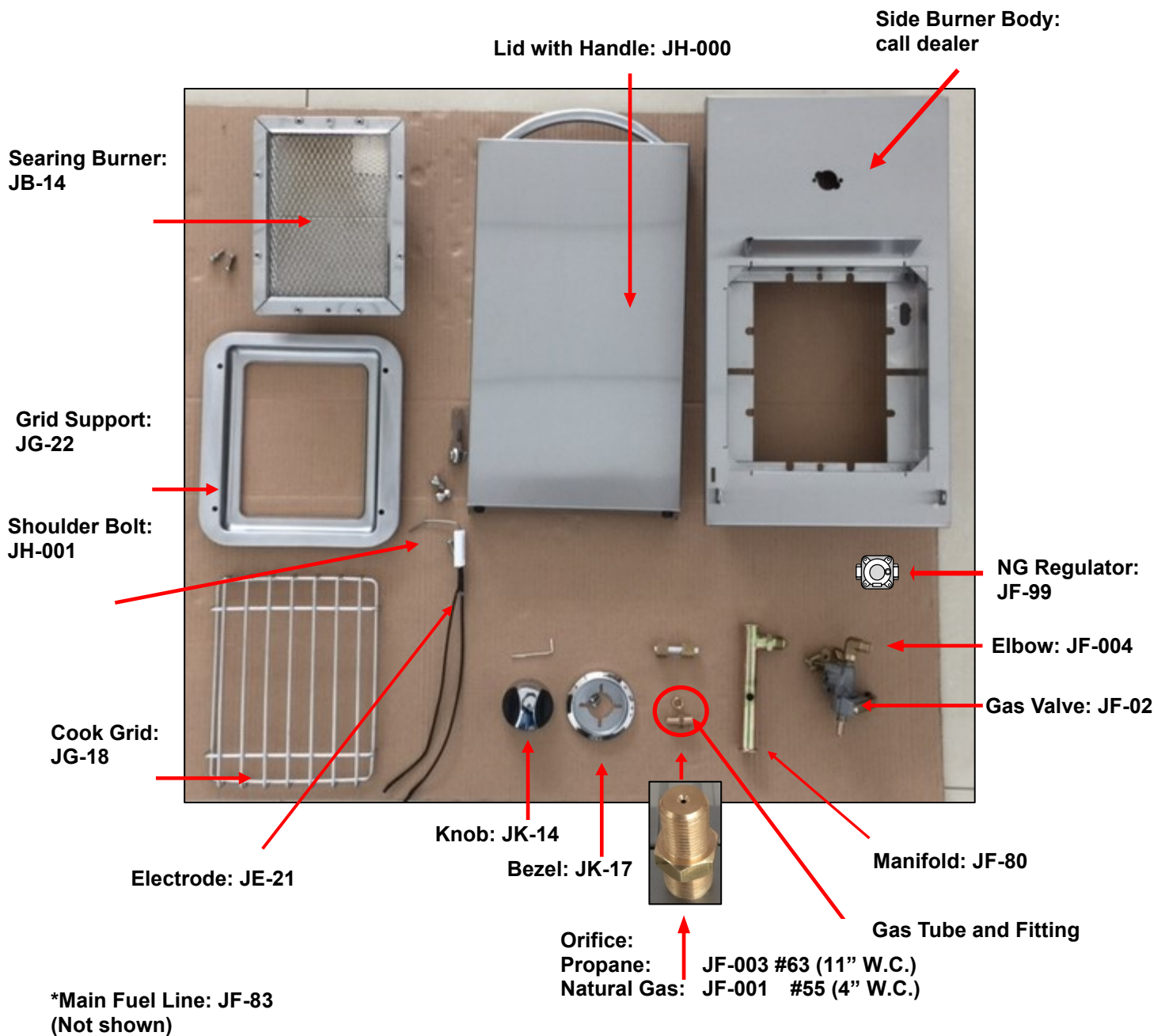

CART MODEL INSTALLATION:

TOOLS REQUIRED:

1 x 11/16mm wrench
 2 x 3/4 mm wrench
 (Or 2 crescent wrenches)

!WARNING!
 SHUT OFF FUEL before
 attempting to install this side
 burner assembly.

STEP 1

Remove the right hand folding side shelf. (The sear burner can only be installed on the right-hand side of the unit, as it corresponds with the manifold).

STEP 2

Install supplied right hand side shelf using the 7 screws supplied (Fig 1) and drop side burner into shelf. Bend formed rails down if necessary.

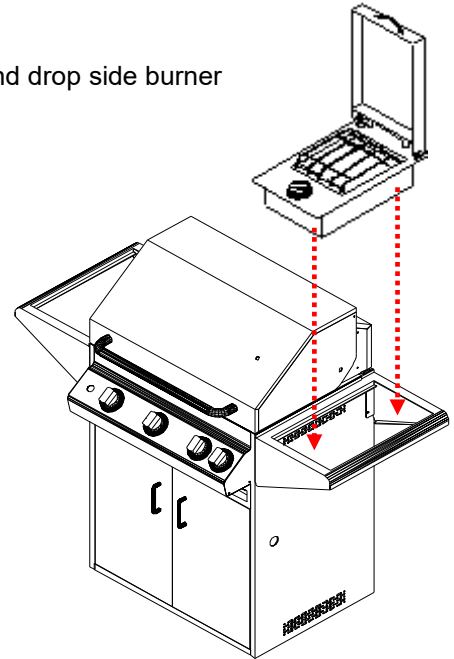
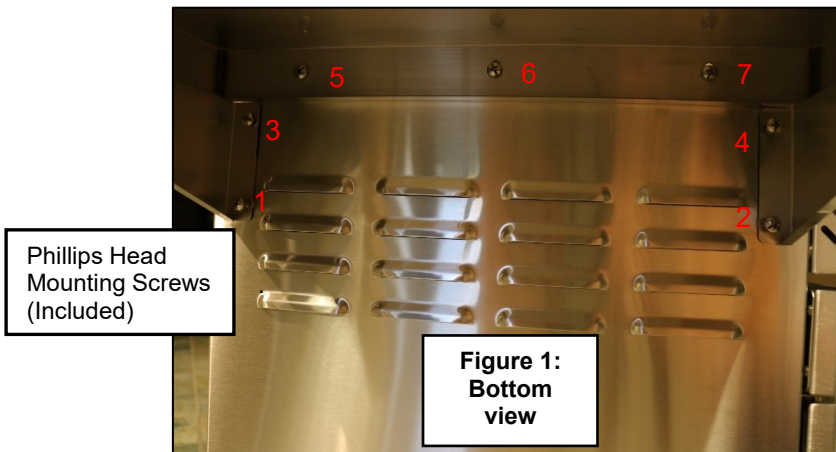

STEP 3

Using the four bolts provided, fasten the side burner to the side shelf. The bolts screw in through the burner into the shelf. (Fig. 2). Note the picture is for illustrative purposes only and the bolt will be screwed into the side shelf.

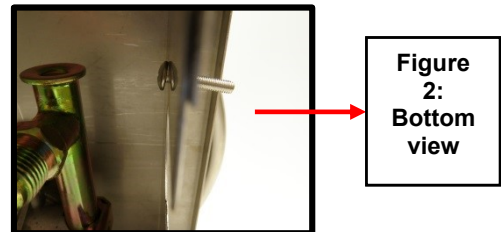

STEP 4

Install the stainless steel flexible fuel line onto the 3/8" flared connection on side burner gas manifold. (Fig. 3: Sealant not required).

STEP 5

Next, insert the flexible fuel line through the hole in left pedestal wall of the barbeque. Note that the hole should be factory equipped with a grommet to protect the fuel line. Remove the cap at the fuel manifold on your grill (Fig.4, 5), then connect the flex line as shown (Fig. 6).

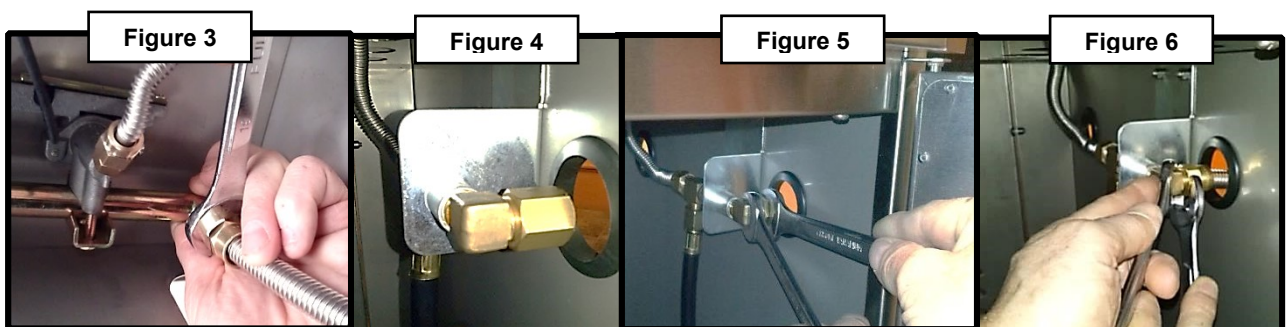

INSTALLATION INTO BUILT-IN CABINET:

STEP 1

Cut hole in cabinet to size as shown in Figure 7 (J,K,L; High-lighted in Yellow).

!WARNING!
SHUT OFF FUEL before
attempting to install this
side burner assembly.

Figure 7

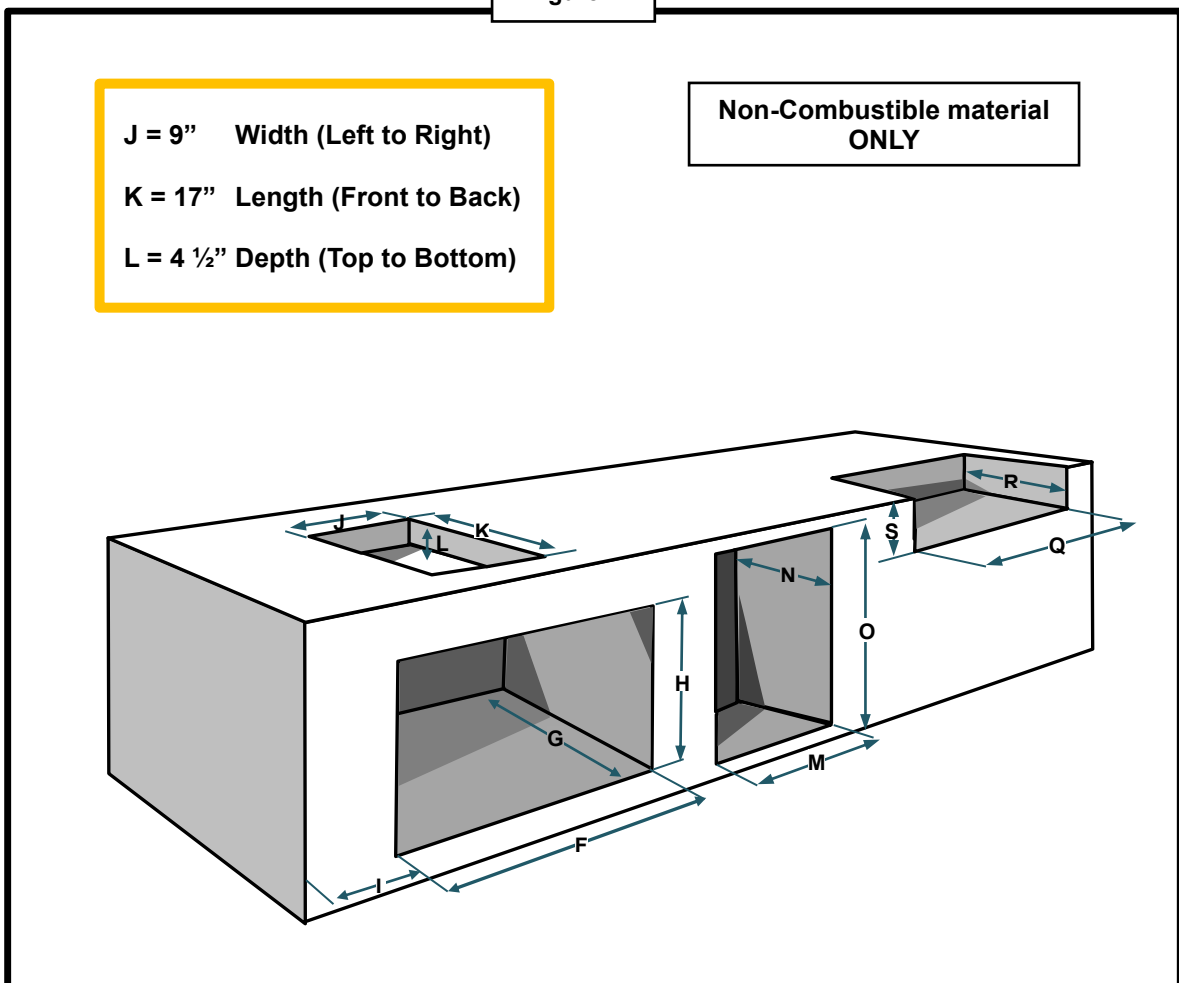

STEP 2

Install inlet fuel line and connect to Searing Side Burner at the 3/8" flared connection. (Sealant not required at this connection).

PROPANE: if the fuel line is installed independently of the BBQ Grill, a fuel regulator MUST be connected so that inlet pressure is set at 11" Water Column.

NATURAL GAS: please ensure that inlet pressure does not exceed 4" Water Column. If the fuel line is installed independently of the barbecue grill, a fuel regulator must be connected so that inlet pressure does not exceed 4" water column to the searing burner.

TECH TIP
A Certified Gas Fitter
should be used to install
fuel lines and other fuel
related components.

Lid Lock Instructions:

1. ONLY operate the searing burner when the lid is open. (Fig. 8)
2. When preparing to operate, you must open the lid cover fully and engage the lid locking device (Fig. 8)
3. To release the lid locking device, manually lift the locking device and gently close the lid cover. (Fig 9 &10)

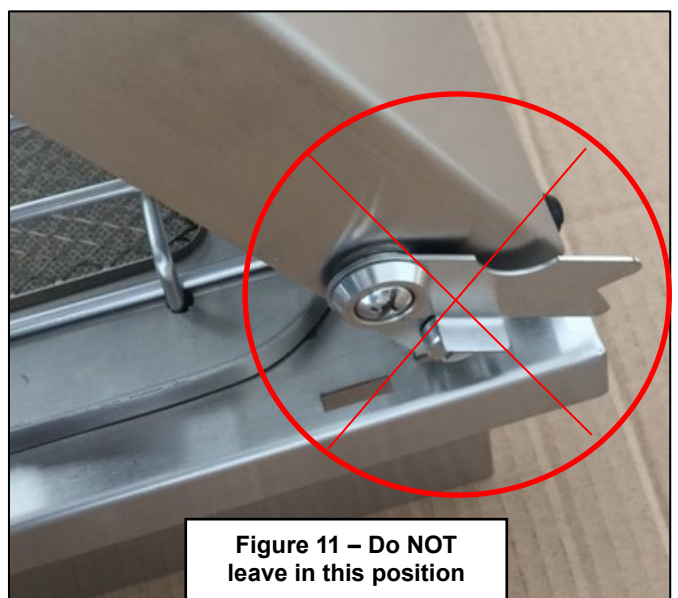
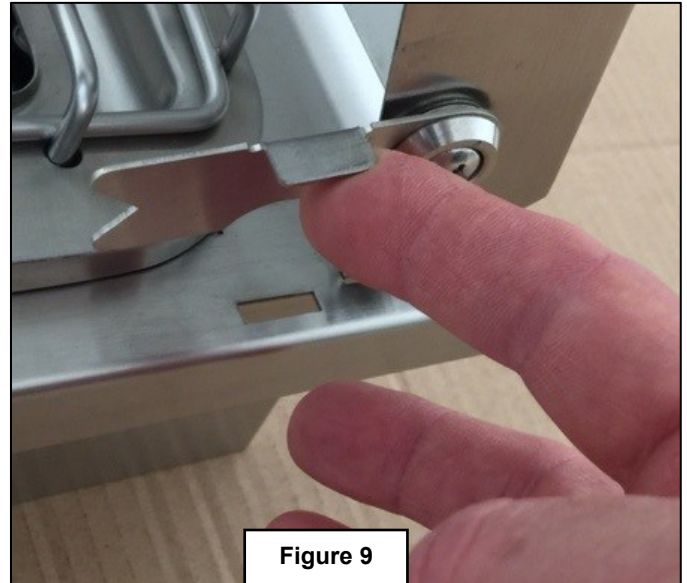

Clearance to Combustibles:

A) **TOP:** from top of grate to any combustibles* above unit:

Do not use this appliance under unprotected overhead combustible materials.

*Such as decks, ceilings, hanging plants, etc.

B) **REAR:** from rear of unit to any combustibles behind unit:

6 inches minimum

C) **SIDE:** from the outside edges of the unit to any adjacent combustibles:

6 inches minimum

!WARNING!

Please allow extra space when the unit is backed up to vinyl siding; exhaust exiting the rear of the unit can warp or melt the vinyl.

LEAK TESTING:

STEP 1

Mix a solution of liquid dish soap and water (or obtain profession leak detector liquid).

Turn on Gas.

STEP 2

Spray or brush detector liquid thoroughly on all fuel line connections (Fig.8). If soap bubbles are generated at any connection, tighten the fitting and re-test. If a leak is detected that cannot be successfully repaired, immediately **turn off the gas** and contact your dealer for further assistance.



LIGHTING INSTRUCTIONS:

1. Turn the main gas supply ON.
2. Depress the side burner control knob down slightly and turn **SLOWLY** counter clock wise until the 'click' of the igniter is heard. (This side burner has a built in ignition system).
3. If the side burner does NOT light, turn the control knob to the OFF position and try again.
4. Once the burner has lit, turn the control knob counter clock wise to the desired heat level.

NOTE: To turn the unit off, turn the gas control clockwise to the OFF position.

GAS CONVERSION: (Optional Orifices not included)

Parts Needed for an LP AND NG Conversion	Parts Needed for an LP Conversion	Parts Needed for a NG Conversion
1 X 2mm or 5/64" Hex key 1 X Phillips screwdriver 1 X 12mm wrench 1 X 13mm wrench 1 X 14mm wrench 1 X 17mm wrench (Or you may choose to use 2 Crescent wrenches)	JF-003: Orifice size #63	JF-001: Orifice size #55 JF-99: 4" WC NG regulator

1. Work on a clean, protected surface to prevent scratching and damages.
2. Remove the main knob using a 2mm or 5/64" Hex Key. Find the key hole at the base of the knob.
3. With a Phillips screw driver, loosen the screw that holds the bezel. Ensure they are very loose. (Fig. 13)

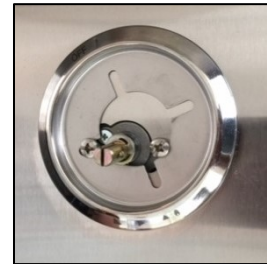

Figure 13

4. Close the main lid and flip the unit over to reveal the valve and fittings on the underside. (Fig. 14)
5. Using a 12 mm wrench, remove the brass nut that anchors the orifice and fittings to the orifice retention bracket

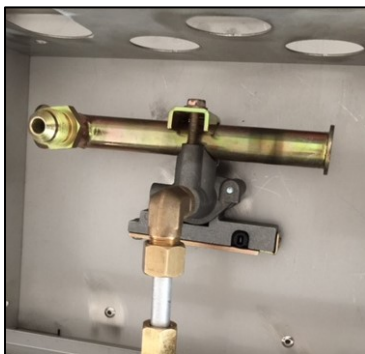
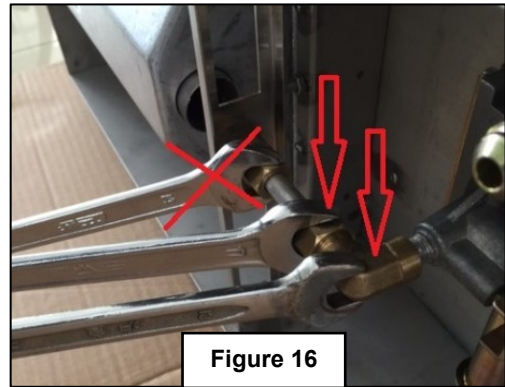

Figure 14

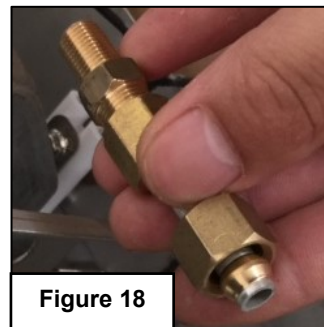
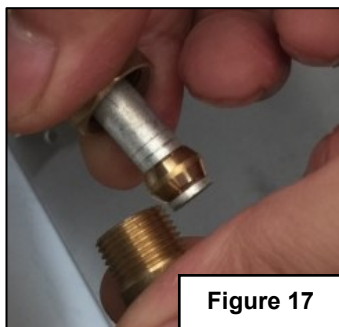

Figure 15

6. Using a 13mm and a 17mm wrench, completely loosen the brass retention nut on the gas tubing from the brass 90° elbow on the valve side. Once loosened, pull the brass retention nut slightly away from the 90° brass elbow. You will do this by slightly turning the brass retention nut and sliding it away at the same time. (Fig 16)



7. Pull back slightly on the valve assembly that you loosened earlier. You will separate the valve assembly from the gas tube and fittings assembly. This will allow you to remove the gas tube and fittings assembly so that you can remove and replace the orifice. (Fig. 17 &18)



8. Using a 14mm and a 12mm wrench, separate the orifice from the gas tubing and fittings assembly. (Fig. 19)

9. Install the new Orifice into Side Burner*

10. Repeat above steps in reverse to reassemble the unit.

11. Test the appliance at all fittings for leaks

12. Propane; Please ensure that the fuel source is regulated to 11" WC.

13. Natural Gas; Please ensure that the fuel source is regulated to 4" WC.



***NOTE: Contact your dealer for conversion Orifices.**

TECH TIP
Do NOT over tighten orifice; threads can easily be broken off!



Limited Warranty:

MODELS: JGSBSEAR-LP & JGSBSEAR-NG Searing Side Burner

Jackson Grills warrants the materials and workmanship in this accessory to be free of defects for two (2) years from the date of purchase, to the original purchaser only.

Two (2) Year Limited Warranty Subject to the following Conditions & Limitations:

NOTE1: Shipping and Labor Charges are NOT covered under this warranty.

NOTE2: Bill of Sale MUST be presented at time of warranty claim.

- Jackson Grills warrants its products to the original purchaser only (NO EXCEPTIONS). The bill of sale (proof of purchase) and serial number will be required in order to claim warranty from your authorized dealer.
- This factory warranty is non-transferable and may not be extended under any circumstances.
- This Limited Warranty does not cover any damage caused by misuse, lack of maintenance, hostile environments, accident, alterations, abuse or neglect, including scratches, dents, corrosion, or discoloring by heat (all stainless steel will discolor), and abrasive or chemical damage resulting from use of harsh cleaners.
- Should deterioration occur to the point of non-performance within the duration of the warranted coverage, a replacement will be provided in the first year only. This warranty extends to the repair or replacement of warranted parts that are defective in materials or workmanship provided that the product has been operated in accordance with the operation instructions and under normal conditions.
- After the first year Jackson Grills reserves the right to fully disengage all obligations with respect to this Limited Warranty by refunding the original warranted purchaser the original wholesale price of the warranted parts.
- Genuine Jackson parts must always be used; use of parts supplied by other manufacturers will nullify the warranty.
- The installation must be done in accordance with the installation procedures described in the included owner's manual.
- Jackson Grills or its parties will not be responsible for the installation, labor or any other costs or expenses related to the refitting of the warranted part, and such expenses are not covered by this warranty.
- Notwithstanding any provision contained in this Limited Warranty, Jackson Grills responsibility under this warranty is defined as above and it shall not in any event extend to any incidental, consequential, or indirect damages.
- Jackson Grills neither assumes, nor authorizes any third party to assume, on its behalf, any other liabilities with respect to the sale of this product.
- Jackson Grills reserves the right to inspect any parts prior to approving warranty claim.
- Jackson Grills or its representatives shall not be liable for ANY shipping charges, labor charges or duties.