

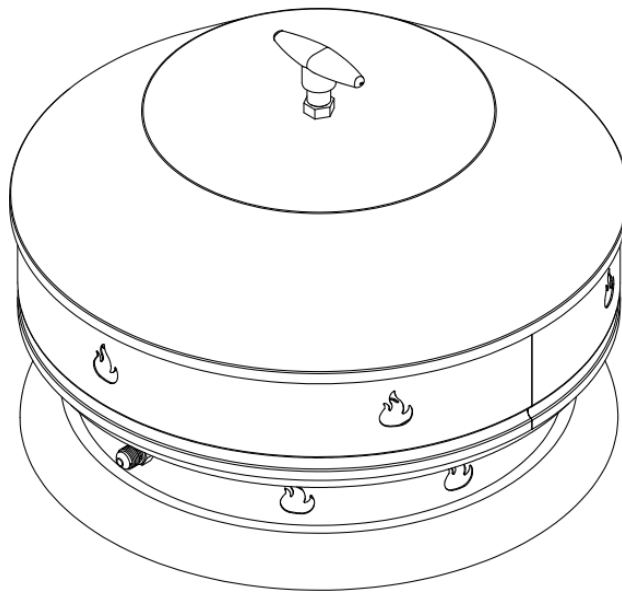

The ultimate outdoor grilling experience.

Phone: 1 (888) 287-3333 ♦ Fax: 1 (877) 855-5373 ♦ #106-2480 Mt. Lehman Road, Abbotsford, BC V4X 2N3

OWNER'S MANUAL for Patio Fire



For Portable Gas Camp Fire: Model # JFP-LP

Important Notice

Please read ALL safety notices on PP.3 & PP.4
before assembling or operating this Patio
Fire.



TABLE OF CONTENTS:

Specifications:	3
Safety Warnings:	2
Warranty Registration:	4
Certification Info:	5
Package Contents Checklist:	5
Assembly & Preparation:	5-6
Lighting & Shutoff Instructions:	6
Natural Gas Conversion Instructions:	8
Care & Maintenance:	9
Storage	10-11
Parts List:	11
Warranty:	12

SPECIFICATIONS:

Input:	46,500 BTU/h (13.6 KW/h)
Manifold Pressure:	11 inch W.C. (2.74 KPa)
Maximum Gas Supply Pressure:	13 inch W.C. (3.50 KPa)
LP Orifice Size:	# 47.
NG Orifice Size (for Conversion Purposes):	# 35
Recommended propane cylinder size:	20 lbs.
Run Time using a 20 lb Cylinder of Propane:	8-10 hours
Minimum distances to combustibles – sides	16" (406mm)
Minimum distance to combustibles – above	84" (2134mm)
Base must sit on a non-combustible surface	

!SAFETY WARNINGS!

IMPORTANT: Please read and understand all warnings and precautions before using your Patio Fire.



!DANGER!

If you smell gas:

1. Shut off gas to the appliance.
2. Extinguish any open flame.
3. Open lid.
4. If the odor continues, keep away from appliance and immediately call your gas supplier or your fire department.



!WARNING!

Do not store or use gasoline or other Flammable liquids in the vicinity of this or any other appliance.
An LP cylinder not connected for use shall not be stored in the vicinity of this or any other appliance.



!WARNING!

For Outdoor Use Only.



!DANGER!

This appliance can produce carbon monoxide which has no odor. Using it in an enclosed space can kill you. Never use this appliance in an enclosed space such as a camper, tent, car or home

WARNING: Improper installation, adjustment alteration, service or maintenance can cause injury or property damage. Read the installation, operating and maintenance instructions thoroughly before installing or servicing this equipment.

- 1 The installation of this Patio Fire must conform to local codes or, in the absence of local codes, with the B149.1 Natural Gas and Propane Installation Code in Canada, or the National Fuel Gas Code, ANSI Z223.1 in the USA
- 2 This Patio Fire must be installed according to manufacturer instructions. Carefully read all the instruction in this manual first. Consult the building authority having jurisdiction to determine the need for a permit prior to commencing the installation.
- 3 Installation, service and repair should be done by a qualified installer, service agency or gas supplier.
- 4 This Patio Fire is set up from the factory for use with Propane Gas (LP) only.
- 5 This appliance should be inspected before the first use and, at least annually by a qualified service person. More frequent cleaning may be required as necessary. It is imperative the controls, burners and circulating air passageways of the appliance be kept clean.
- 6 Failure to follow manufacturer's instructions may void your fire insurance and/or warranty.
- 7 Do not use this Patio Fire until it is COMPLETELY assembled, all parts are securely installed, and leak testing has been completed.
- 8 Do not use this outdoor Patio Fire appliance for any purposes other than intended.
- 9 To prevent injury, do not allow anyone who is unfamiliar with this appliance to operate this appliance.

- 10 Children and adults should be alerted to the hazards of high surface temperatures and should stay a safe distance away to avoid injury or ignition of clothing. Young children should be carefully supervised when they are in the area of this appliance.
- 11 Clothing or other flammable materials should not be hung from the appliance, or placed near the appliance.
- 12 Position the gas hose out of the pathways to avoid a tripping hazard.
- 13 Do not burn solid fuels in this appliance. Do not use gasoline, alcohol or other volatiles for lighting.
- 14 Do not use this Patio Fire if any part has been under water. Immediately call a qualified service technician to inspect the appliance and to replace any part of the control or gas control systems that have been under water.
- 15 Always place the Patio Fire on a hard non-combustible level surface away from combustible materials. Do not attempt to move this Patio Fire while lit.
- 16 To avoid burns, do not touch any metal surfaces on this Patio Fire until it has completely cooled.
- 17 It is essential to keep the gas valve, burner, and base tray free of obstructions and debris. Inspect the Patio Fire before each use.
- 18 Propane (LP) gas supply cylinders must be constructed and marked in accordance with the specifications for propane gas cylinders of the US Department of transport (DOT) CFR 49 or the National Standards of Canada, CAN/CSA B339, Cylinders, Spheres and Tubes for the Transportation of Dangerous Goods.
- 19 For appliances designed to use a CGA 791 Propane Gas Connection: Place dust cap on cylinder valve outlet whenever the cylinder is not in use. Only install the type of dust cap on the propane cylinder valve outlet, this provided with the cylinder valve. Other types of caps may result in leakage of propane gas.
- 20 Never fill any LP Gas Cylinder more than 80 percent full. Dented and rusted propane cylinders may be hazardous and must be checked by a propane gas supplier, before use.
- 21 **WARNING:** if the information in #18 and #19 are not followed exactly, a fire causing death or serious injury may occur.
- 22 To prevent propane from entering the regulator valve & causing a potential hazard, please ensure that the propane cylinder is at a lower level than the regulator when in use.
- 23 Please note that propane (LP) is explosive under pressure, heavier than air, and settles and pools in low areas, which can create an explosion hazard.
- 24 The fuel line for this appliance must be disconnected from the gas supply piping system during any pressure testing of that system, at test pressures in excess of 0.5 psi (3.5 kPa).
- 25 This gas appliance must be isolated from the gas supply piping system by closing its individual manual shutoff valve during any pressure testing of the gas supply piping system at test pressures equal to or less than 0.5 psi (3.5 kPa).
- 26 Inspect fuel supply hose for damage before each use. If excessive wear, abrasion, or cracks are present, the hose **MUST** be replaced with a genuine Jackson Grills replacement part, prior to using this outdoor appliance (Contact your nearest dealer for assistance).
- 27 The Fuel Supply Hose must not touch any hot surfaces, as damage and gas leaks may occur.
- 28 It is recommended that the LP gas cylinder be fastened to a mounting surface using a bracket or concrete anchor (not supplied) depending on the specific surface.

Special Message to Our Customers:

All of us at Jackson thank you, for choosing a Jackson Patio Fire! This appliance was designed, engineered, and built with quality components and we are confident that it will provide you with years of excellent operation.

Please take the time to read the entire manual and familiarize yourself with all of the features of the Jackson Patio Fire. This manual also contains important safety information and operation instructions. Please write your Patio Fire's serial number in the space below.

To obtain replacement parts for your Jackson Patio Fire, contact your local dealer. If you have any question, contact us anytime via phone or email as shown below: (Please have your model and serial number at hand)

Patio Fire Model: JFP-LP Portable Patio Fire

***Serial Number:** _____

*Write your serial number here for future reference.

OWNER REGISTRATION: Please take the time to fill out and return a Warranty Registration Card, or on-line at www.jacksongrills.com or simply fill in the form below and mail or fax to:

Jackson Patio Fires
#106-2480 Mt. Lehman Rd.
Abbotsford, BC.
Canada V4X 2N3

Customer Support (Tel): 1 (888) 287-3333 or
Customer Support (E-mail): info@jacksongrills.com
Fax: 1 (877) 855-5373
Parts Ordering: Contact your Dealer

Please complete and return within 10 days. Thank you.

Title: Mr. Mrs. Ms. Miss (Circle One)

First Name: _____ Initial: _____ Last Name: _____

Street: _____ Apt. #: _____

City: _____ State/Prov.: _____ Zip/Postal: _____

Phone: _____ Email: _____

Date Purchased: _____ Dealer: _____

Model: _____ Serial #: _____

Comments: _____

Thank you for taking the time to fill out this Ownership and Registration Card

Dear Patio Fire Owner; please keep this manual for future reference.

CERTIFICATION & TESTING:

This appliance has been tested by Labtest Certification Inc. (LC), test to ANSIZ271.97-2010 & CSA CAN 1-2.21-M85, Certified for use in Canada and the USA.

PACKAGE CHECK LIST:

PARTS CHECKLIST:

- 1 Lid and Tee Handle
- 1 Wind Guard Ring (Stainless)
- 1 Base Body with burner
- 1 Propane Hose & Regulator
- 1 Log Set
- 1 Bag of Embers
- 1 Bungee Cord
- 1 Owner's Manual
- 1 Natural Gas Conversion Orifice

TECH TIP

Do not throw away packaging until you have confirmed that all parts are present.

ASSEMBLING YOUR PATIO FIRE:

STEP 1:

Remove the lid by twisting the tee handle counter clockwise until the lid assembly is released from the body. Set aside the embers for later installation.

STEP 2:

Check that the hose and regulator assembly is securely fastened to the campfire body. (For use with propane gas).

The LP-gas supply cylinder must be shut off and disconnected when this appliance is not in use.

The LP-gas supply cylinder(s) to be used with this campfire must be arranged for vapor withdrawal and must include a collar to protect the cylinder valve.

The LP-gas supply cylinder(s) must be constructed and marked in accordance with the specifications for the LP-gas cylinders Standards, *CAN/CSA B339, Cylinders, Spheres and Tubes for Transportation of Dangerous Goods*.

STEP 3:

Place the first log gently over the center tube and alignment pin. The burner ports form an outline of the log; this will aid in correct alignment. (fig.1 & 2)

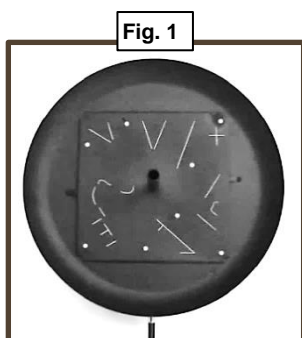

TECH TIP
Logs are fragile!
Handle with care to
avoid breakage.

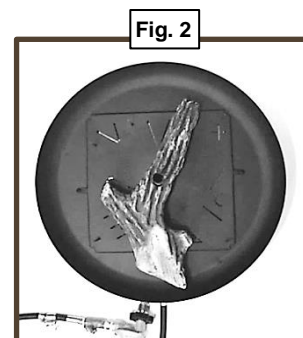

STEP 4:

Place logs #2 and #3 onto the burner as shown. Press onto pins where required. (fig.3 & 4)

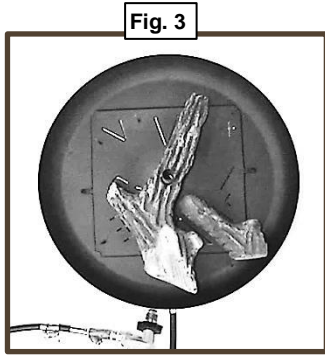

Fig. 3

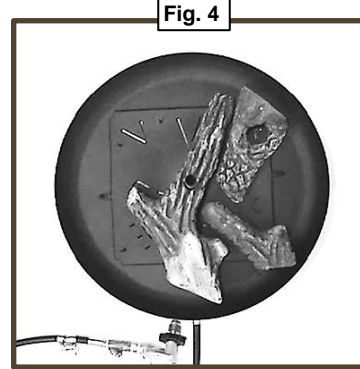

Fig. 4

STEP 5:

Place logs #4 and #5 onto the burner as shown. (fig.5 & 6)

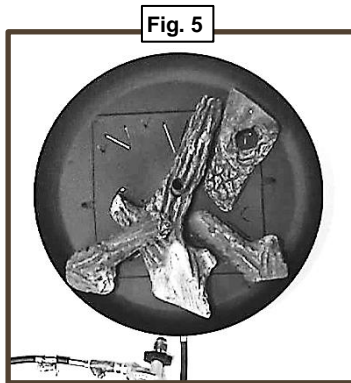

Fig. 5

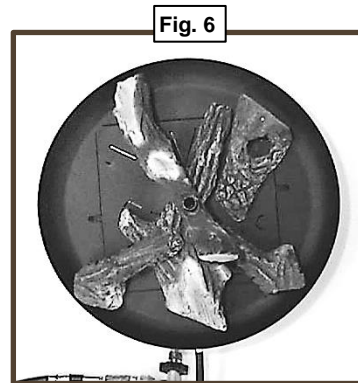

Fig. 6

STEP 6:

Next, place logs #6 onto the burner as shown. Finally, scatter the embers over the exposed areas of the burner pan. Where possible, cover the burner gas slots with embers; this will result in a more esthetically pleasing flame. (fig.7)

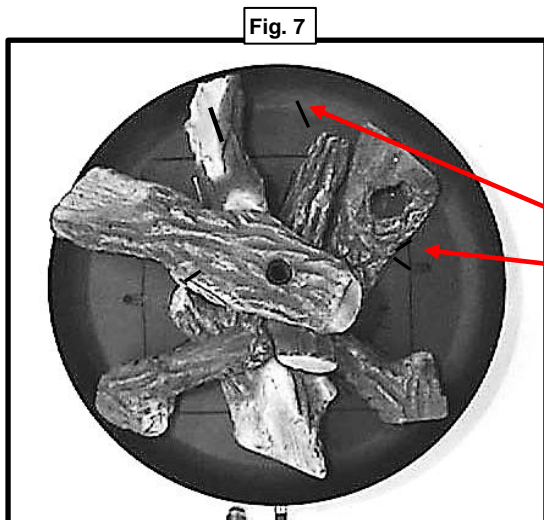

Fig. 7

!WARNING!
Installing the logs & embers in any arrangement other than shown here in this manual, will result in UNSAFE burn characteristics.

Burner Gas lots

LIGHTING INSTRUCTIONS:

1. Inspect the hose and burner for wear or damage. DO NOT LIGHT THE FIRE PIT IF DAMAGE OR WEAR IS FOUND.
2. PROPANE: Attach the regulator assembly to your propane cylinder. NOTE: Make sure your propane cylinder valve is closed.
3. Attach the campfire regulator assembly to your propane cylinder by threading the black plastic QCC fitting clockwise onto the cylinder valve until hand tight (fig 8).
4. NATURAL GAS: check to ensure that the gas source connection is set at 7" water column. Then, connect the natural gas hose to the pre-installed gas connection at the natural gas source on the home.
5. When connecting the Patio Fire to a gas source for the first time, always perform a leak test using a soap and water solution.

Fig. 8

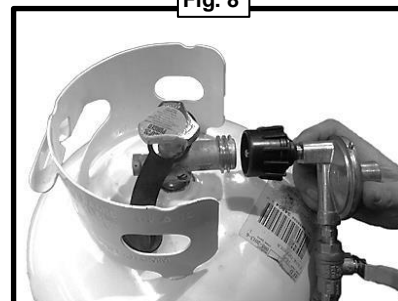

!WARNING!

NEVER use an open flame to check for gas leaks; Injury, death and/or property damage may result.

TECH TIP

To apply the soap solution to check for leaks, use a medium sized artist or hobbyist type paint brush.

- a) Apply the soap solution to the connections at either end of the hose and regulator assembly.
 - b) PROPANE: Open the LP cylinder valve; if bubbles start to form between the valve and the hose there is a leak. Shut off the gas, then remove and reattach the hose. If bubbles continue to form indicating the leak is still there, SHUT OFF the gas and contact the nearest dealer. If no bubbles are seen, leave the gas on, and continue to step 6.
 - c) NATURAL GAS: Open the gas line valve, if bubbles start to form between the valve and the hose there is a leak. Shut off the gas, then remove and reattach the hose. If bubbles continue to form indicating the leak is still there, SHUT OFF the gas and contact the nearest dealer. If no bubbles are seen. Leave the gas on, and continue to step 6.
6. Place a lit match or equivalent on the log set near a burner port (fig 10).
 7. Stand clear of the burner ports, and slowly turn on the gas. (fig 9; shows the propane valve in the "off" position). This Patio Fire may light with a "WOOF"; this is normal and is not dangerous.
 8. The flame intensity can be lowered by slowly closing the gas valve.
 9. TO SHUT OFF Patio Fire: simple turn the On/Off Valve to the off position (red arrow, fig 9). Then shut off fuel source. Note: this unit must be shut off for 5 minutes before restart is permitted.

Fig. 9

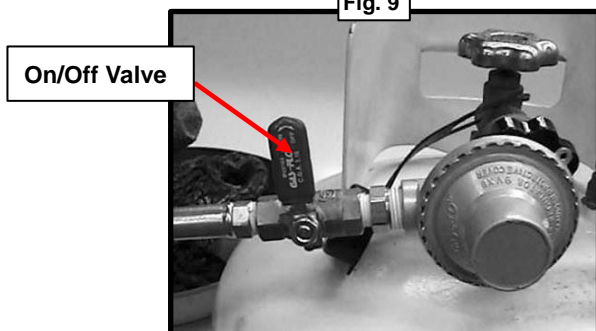
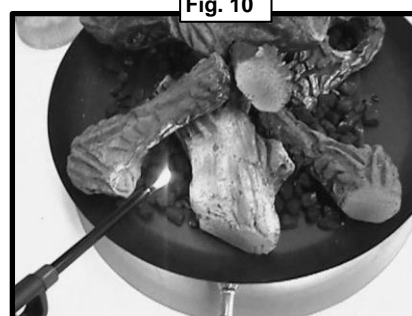

Fig. 10



NATURAL GAS CONVERSION:

NOTE: Natural Gas Conversion Kits are available from your local Jackson dealer. Please ask for part number;

CONNG-JFP Natural Gas Conversion Kit; Patio Fire

Tools Required:

2 Phillips screwdriver

8 and 18 mm wrenches

Adjustable wrench

!WARNING!
BEFORE PERFORMING CONVERSION:
shut off gas at source and shut off Patio Fire valve, then disconnect Patio Fire from gas supply hoses or pipes. Failure to do so presents a fire risk.

FOR NAT/GAS installations where a Quick Release

1. Remove the lid by twisting the tee handle counter clockwise, until the lid assembly is released from the body.
2. Remove logs & embers from unit (if already installed).
3. Using a # 2 Philips screwdriver, remove 2 screws holding the burner in place.
4. Slide back and lift burner out of the fire pit body (fig 11).
5. Using the Philips screwdriver, loosen the screw on the air shutter located on the inlet of the burner (red arrow; fig 11) then turn the shutter so that it is completely closed.
6. Re-tighten the screw. Re-install burner in reverse order
7. Using an 18 mm wrench, remove propane hose assembly (complete with orifice mount fitting) from the Patio Fire body (fig 12).
8. Using an 8 mm wrench, remove the brass propane orifice from the orifice mount fitting on the end of the propane hose. Set it aside, and install the supplied natural gas orifice.(Red arrow; fig 13)
9. Remove the brass orifice mount (with the orifice) from the propane hose, and install the assembly into the threaded female on the natural gas hose assembly (see Figure 13 & 14).
10. Using the 8mm wrench, re-install natural gas hose assembly with new NG orifice, into the fire pit. Re-install logs & embers.

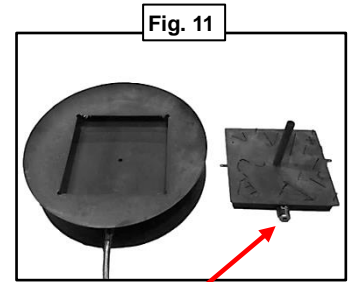

Burner Air Shutter

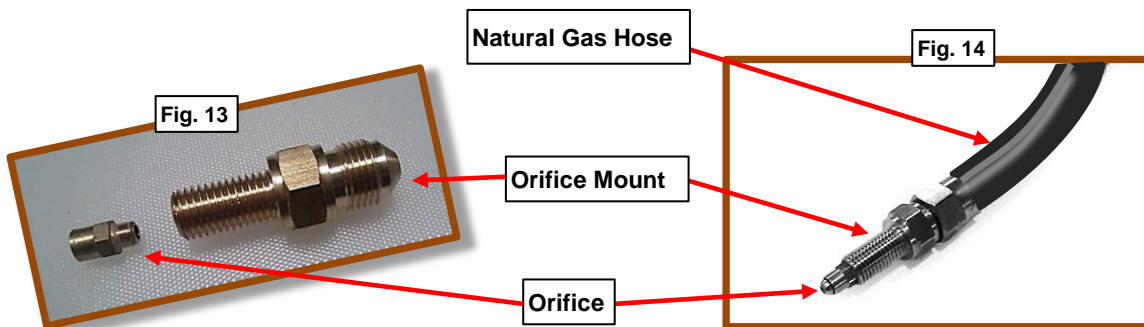
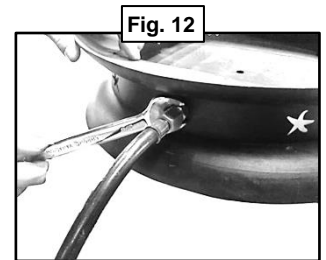

11. Connect Patio Fire to natural gas fuel source, and turn on gas. Next, check all fittings for gas leaks, using a soapy water solution. If a leak is detected, shut off gas at source, and identify and repair leak before proceeding any further.

Care & Maintenance

1. Should your campfire be left out in the rain, simply light it as usual and burn until the log set and embers have dried out and begin to glow.
2. Scratches and stains on the wind guard can be buffed out using a Scotch-Brite pad. Be sure to buff “with the grain” to restore the stainless steel’s natural luster. Stainless polish will protect the surface over the long term.
3. The hose assembly must be checked every time the campfire is lit. If evidence is found of excessive abrasion or wear, or if the hose is damaged the hose must be replaced prior to lighting. (See page 11 for parts list)
4. The burner assembly must be checked every time the campfire is lit. If evidence is found of damage the burner must be replaced prior to lighting. (See page 11 for parts list)
5. The burner may be removed, for cleaning or maintenance by removing the two (2) mounting screws and lifting the burner from the campfire body.
6. To clean the burner, wait until the campfire has completely cooled. Gently remove the log set and embers. CAREFULLY LIFT each log STRAIGHT UP off of the center tube and alignment pins starting from the top down (in the reverse order shown in pages 5 & 6). Pour off and SAVE THE EMBERS. The burner may then be removed. Use a soft brush attachment on a vacuum to clean the whole unit. Re-install the burner and refer to page 5 & 6 to re-install the logs and embers.
7. This campfire, hose, and regulator assembly must be disconnected from the gas supply piping system during any pressure testing of the gas supply piping system at test pressures in excess of 1/2 psi (3.5kPa).
8. This campfire must be isolated from the gas supply piping system by closing its individual manual shutoff valve during any pressure testing of the gas supply piping system at test pressures in equal to or less than 1/2 psi (3.5kPa).
9. Should carbon deposits appear on the log set simply vacuum it off using the soft brush attachment on your vacuum cleaner.

Storage

When the appliance is not in use the LP cylinder must be disconnected. Store your campfire in a dry place. This appliance may be stored indoors but the LP cylinder must be stored outdoors in a well-ventilated area out of reach of children.

- 1) If the Patio Fire is to be transported or stored, the hose and regulator assembly must be wrapped around the center of the base. Do not wrap so tight as to kink the hose at the base connection end. Hook one end of the supplied bungee cord onto the hand wheel of the regulator (figure 15). Make sure that the tank connection faces inward (for protection from damage). Stretch the other end of the bungee around to where the hose attaches to the base, and hook on (fig 16).

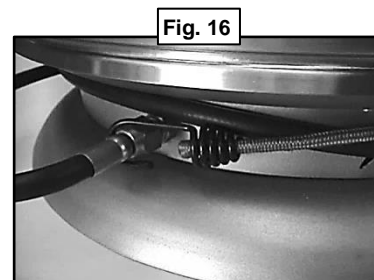
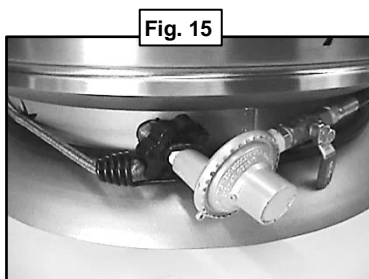

- 2) Disconnected cylinders must have threaded valve plugs tightly installed and must not be stored in a building, garage or any other enclosed area.
- 3) Enclosures for LP-gas supply cylinders shall be ventilated by openings at the level of the cylinder valve and at floor level. The effectiveness of the opening(s) for the purposes of ventilation shall be determined with the LP-gas supply cylinder(s) in place. This shall be accomplished by one of the following:
 - a) One side of the enclosure shall be completely open; or
 - b) For an enclosure having four (4) side, a top and a bottom:
 1. At least two (2) ventilation openings at cylinder valve level shall be provided in the side wall, equally sized, spaced at 180 degrees (3.14 rad), and unobstructed. Each opening shall have a total free area of not less than 1/2 square inch per pound (3.2 sq. cm/kg) of stored fuel capacity and not less than a total free area of 10 square inches (64.5 sq. cm).
 2. Ventilation opening(s) shall be provided at floor level and shall have a total free area of not less than 1/2 square inch per pound (3.2 sq. cm/kg) of stored fuel capacity and not less than a total free area of 10 square inches (64.5 sq. cm). If ventilation openings at floor level are in a sidewall, there shall be at least two (2) openings. The bottom of the openings shall be at floor level and the upper edge no more than 5 inches (127 mm) above the floor. The openings shall be equally sized, spaced at 180 degrees (3.14 rad), and unobstructed.
 3. Every opening shall have minimum dimensions so as to permit the entrance of a 1/8 inch (3.2 mm) diameter rod.
- 4) The cylinder's valve shall be readily accessible for hand operation. A door on the enclosure to gain access to the cylinder valves is acceptable, provided it is non-locking and can be opened without the use of tools.
- 5) There shall be a minimum clearance of 2 inches (50.8 mm) between the lower surface of the floor of the LP-gas supply cylinder enclosure and the ground.

Advertisement:

Introducing the ISLAND GRILLSTONE™, the exciting new natural basalt grilling accessory for BBQ enthusiasts. Great for cooking those delicate foods, such as asparagus, chicken breasts, seafood, etc. Available from your Jackson dealer.

Part Number GRILLSTONESQ (14" x 14")



Parts List:

Part Number	Part Description
JP-01	Tee Handle Assembly
JP-02	Lid
JP-03	Wind guard
JP-11	Log set
JP-04	Embers Not Shown
JP-05	LP Burner
JP-06	Body
JP-07	LP Hose & Regulator Assy.
JP-08	LP Orifice Mount Assembly
JP-09	Bungee Cord
n/a	Owner's Manual
JP-23	Main Lid with handle and bolt assembly

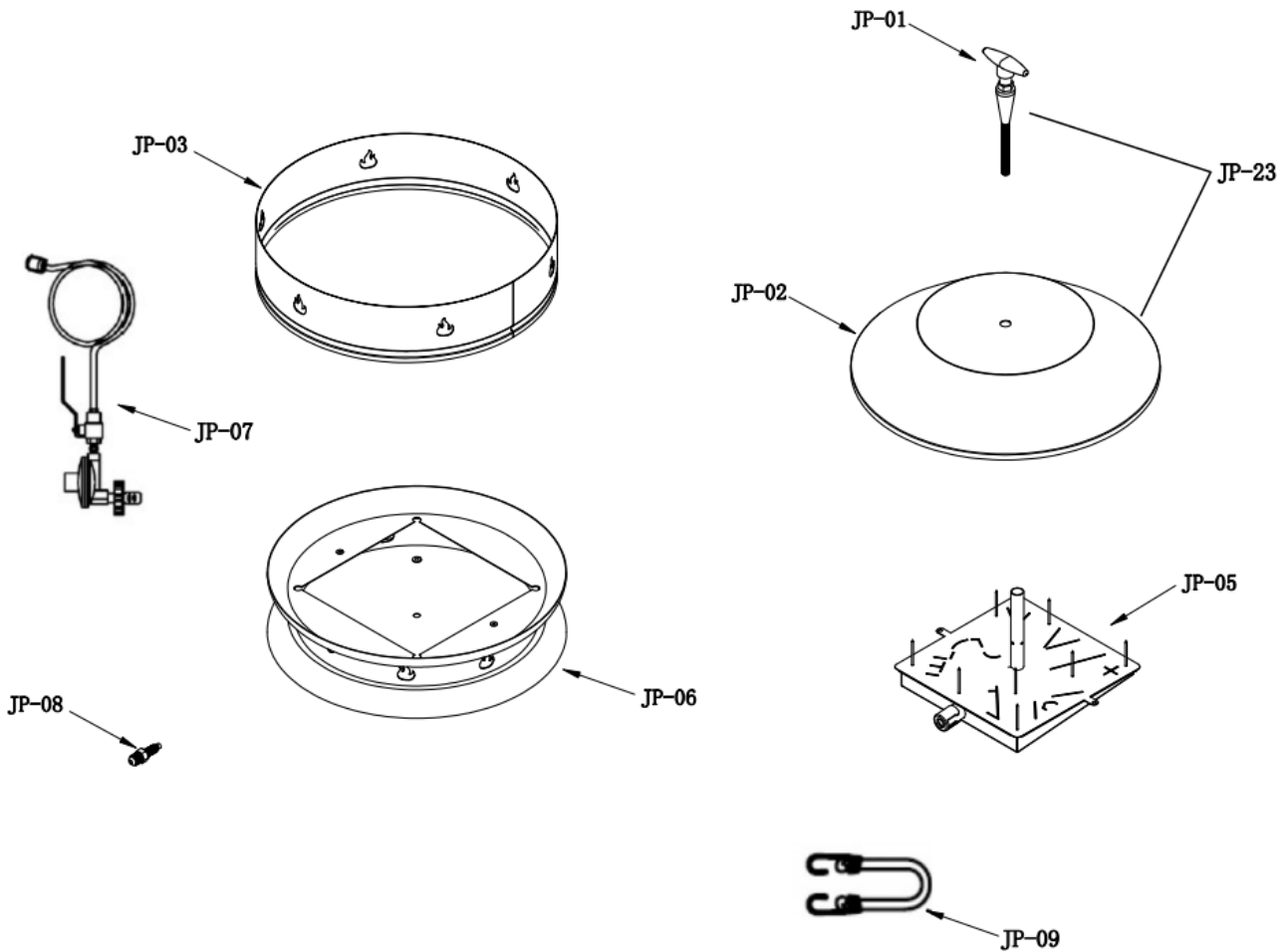

JFP-LP Patio Fire Warranty:

MODEL: JFP-LP Portable Patio Fire

One (1) Year Warranty:

Jackson Grills provides a one (1) year warranty for the Jackson JFP-LP Patio Fire. Under this warranty, Jackson covers all defects in materials and workmanship, for replacement of the affected part, for a period of one year. Please note the following exclusions and limitations:

One Year Warranty Subject to the following Conditions & Limitations:

(NOTE: Shipping and Labor Charges are NOT covered)

- Jackson Patio Fires warrants its products to the original purchaser only (NO EXCEPTIONS) The bill of sale (proof of original ownership) will be required in order to claim warranty from your authorized dealer.
- Jackson Patio Fires or its parties will not be responsible for the installation, labor or any other costs or expenses related to the refitting of the warranted part, and such expenses are not covered by this warranty.
- This factory warranty is non-transferable and may not be extended under any circumstances.
- Notwithstanding any provision contained in this Limited Warranty, Jackson Patio Fires responsibility under this warranty is defined as above and it shall not in any event extend to any incidental, consequential, or indirect damages.
- This Limited Warranty does not cover any damage caused by misuse, lack of maintenance, hostile environments, accident, alterations, abuse or neglect, including scratches, dents, corrosion, or discoloring by heat and abrasive or chemical damage resulting from use of harsh cleaners.
- Jackson Patio Fires neither assumes, nor authorizes any third party to assume, on its behalf, any other liabilities with respect to the sale of this product.
- Genuine Jackson parts must always be used; use of parts supplied by other manufacturers will nullify the warranty.
- Jackson Patio Fires reserves the right to inspect any parts prior to approving warranty claim.
- The installation must be done in accordance with the installation procedures described in the included owner's manual.
- Jackson Patio Fires or its representatives shall not be liable for ANY shipping charges, labor charges or duties.